



STPS80L15CY

LOW DROP OR-ing POWER SCHOTTKY RECTIFIER

PRELIMINARY DATASHEET

MAIN PRODUCT CHARACTERISTICS

I_{F(AV)}	2 x 40 A
V_{RRM}	15 V
T_j (max)	125 °C
V_F (max)	0.33 V

FEATURES AND BENEFITS

- Max247 PACKAGE, DUAL DIODE CONSTRUCTION, 2 x 40A
- 15V BLOCKING VOLTAGE SUITABLE FOR 5V AND 12V OR-ing
- EXTREMELY LOW VOLTAGE VOLTAGE DROP: 0.33V @ 100°C
- OPERATING JUNCTION TEMPERATURE: 125°C
- AVALANCHE CAPABILITY SPECIFIED

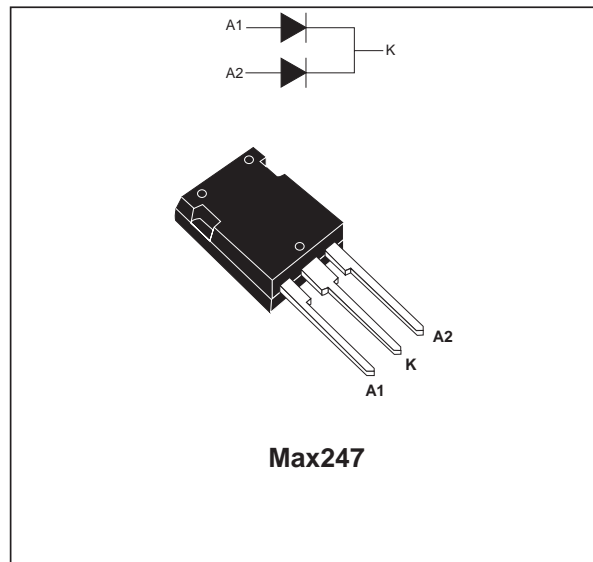

DESCRIPTION

The STPS80L15CY uses proprietary barrier technology to optimize forward voltage drop for OR-ing functions in n-1 fault tolerant Switch Mode Power Supplies.

ABSOLUTE RATINGS (limiting values, per diode)

Symbol	Parameter	Value	Unit
V _{RRM}	Repetitive peak reverse voltage	15	V
I _{F(RMS)}	RMS forward current	50	A
I _{F(AV)}	Average forward current	T _c = 110°C δ = 0.5 Per diode: 40 Per device: 80	A
I _{FSM}	Surge non repetitive forward current	t _p = 10 ms sinusoidal	400 A
I _{RRM}	Repetitive peak reverse current	t _p = 2 μs F = 1kHz square	2 A
P _{ARM}	Repetitive peak avalanche power	t _p = 1μs T _j = 25°C	36045 W
T _{stg}	Storage temperature range	- 65 to + 150	°C
T _j	Maximum operating junction temperature	125	°C
dV/dt	Critical rate of rise of reverse voltage	10000	V/μs

THERMAL RESISTANCES

Symbol	Parameter		Value	Unit
R _{th(j-c)}	Junction to case	Per diode	0.7	°C/W
		Total	0.5	
R _{th(c)}		Coupling	0.3	

When the diodes 1 and 2 are used simultaneously :
 $\Delta T_j(\text{diode } 1) = P(\text{diode } 1) \times R_{th(j-c)}(\text{Per diode}) + P(\text{diode } 2) \times R_{th(c)}$

STATIC ELECTRICAL CHARACTERISTICS (per diode)

Symbol	Parameter	Tests conditions		Min.	Typ.	Max.	Unit
I _R *	Reverse leakage current	T _j = 25°C	V _R = 5V			4	mA
		T _j = 100°C			280	400	
		T _j = 25°C	V _R = 12V			11	A
		T _j = 100°C			0.44	1.1	
		T _j = 25°C	V _R = 15V			16	mA
		T _j = 100°C			0.53	1.3	
V _F *	Forward voltage drop	T _j = 25°C	I _F = 40 A			0.42	V
		T _j = 100°C	I _F = 40 A		0.30	0.33	
		T _j = 25°C	I _F = 80 A			0.55	
		T _j = 100°C	I _F = 80 A		0.40	0.46	

Pulse test : * t_p = 380 μs, δ < 2%

To evaluate the maximum conduction losses use the following equation :

$$P = 0.20 \times I_{F(AV)} + 0.0032 \times I_{F(RMS)}^2$$

Fig. 1: Average forward power dissipation versus average forward current (per diode).

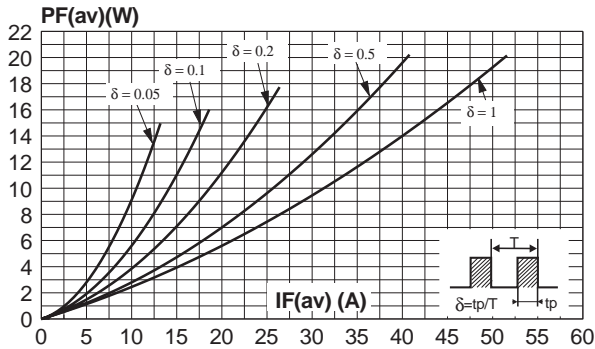

Fig. 2: Average forward current versus ambient temperature ($\delta=0.5$, per diode).

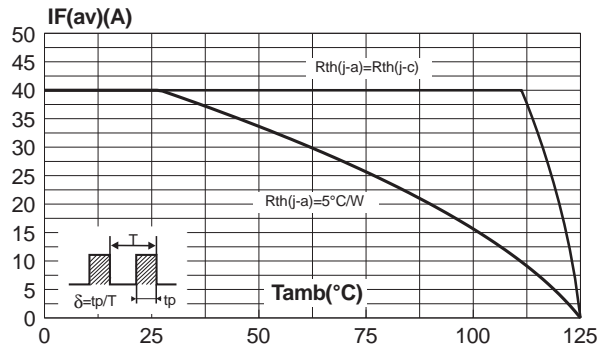

Fig. 3: Normalized avalanche power derating versus pulse duration.

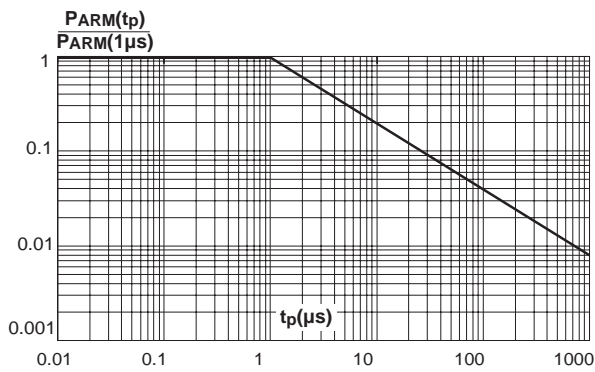

Fig. 4: Normalized avalanche power derating versus junction temperature.

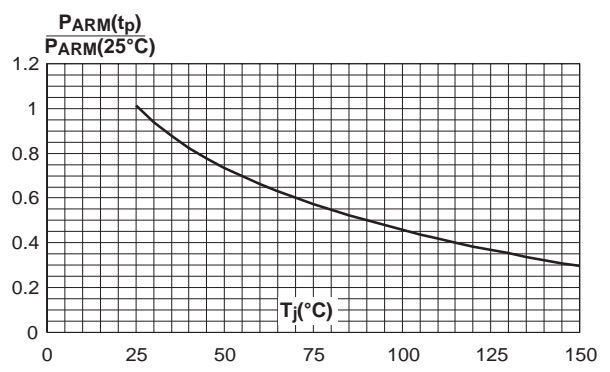

Fig. 5: Non repetitive surge peak forward current versus overload duration (maximum values, per diode).

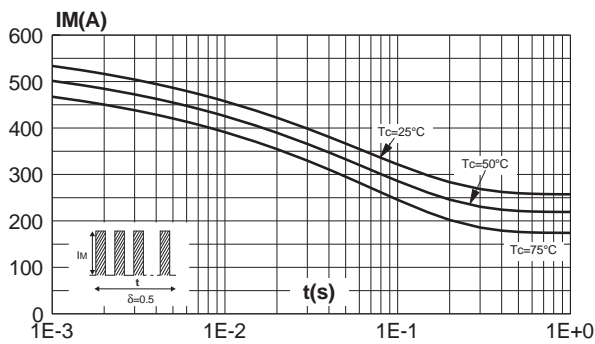

Fig. 6: Relative variation of thermal impedance junction to case versus pulse (per diode).

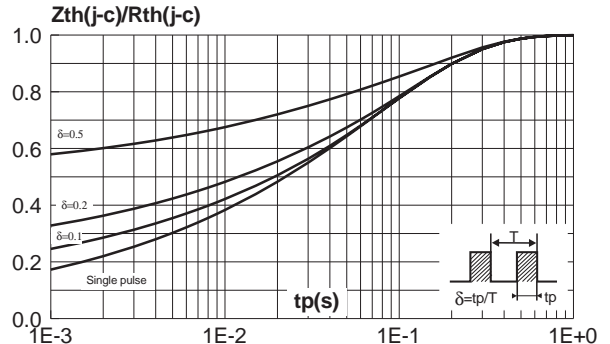

Fig. 7: Reverse leakage current versus reverse voltage applied (typical values, per diode).

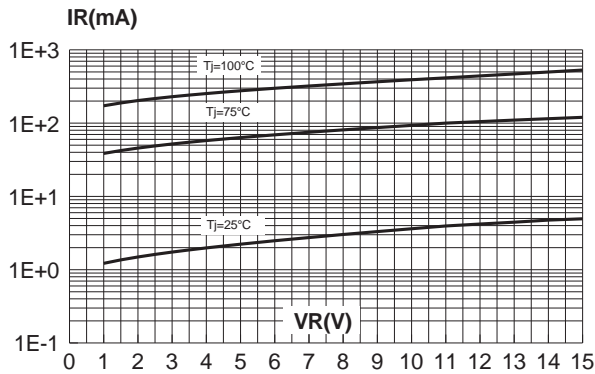

Fig. 8: Junction capacitance versus reverse voltage applied (typical values, per diode).

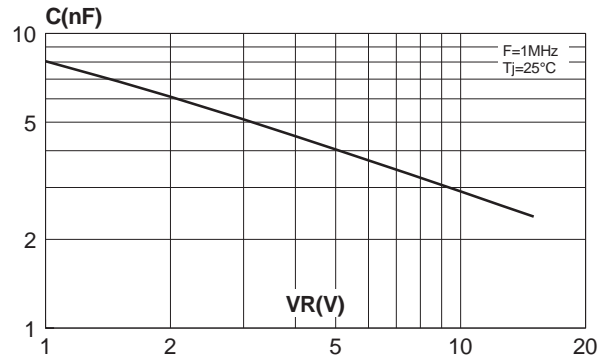
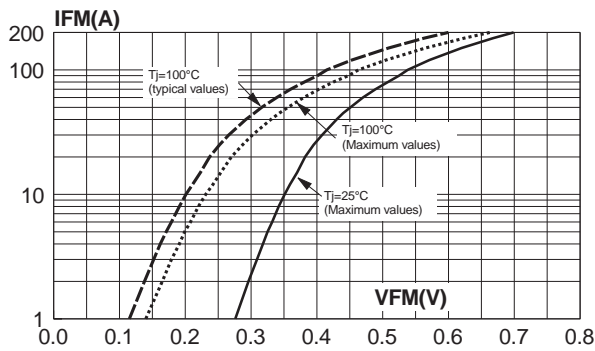
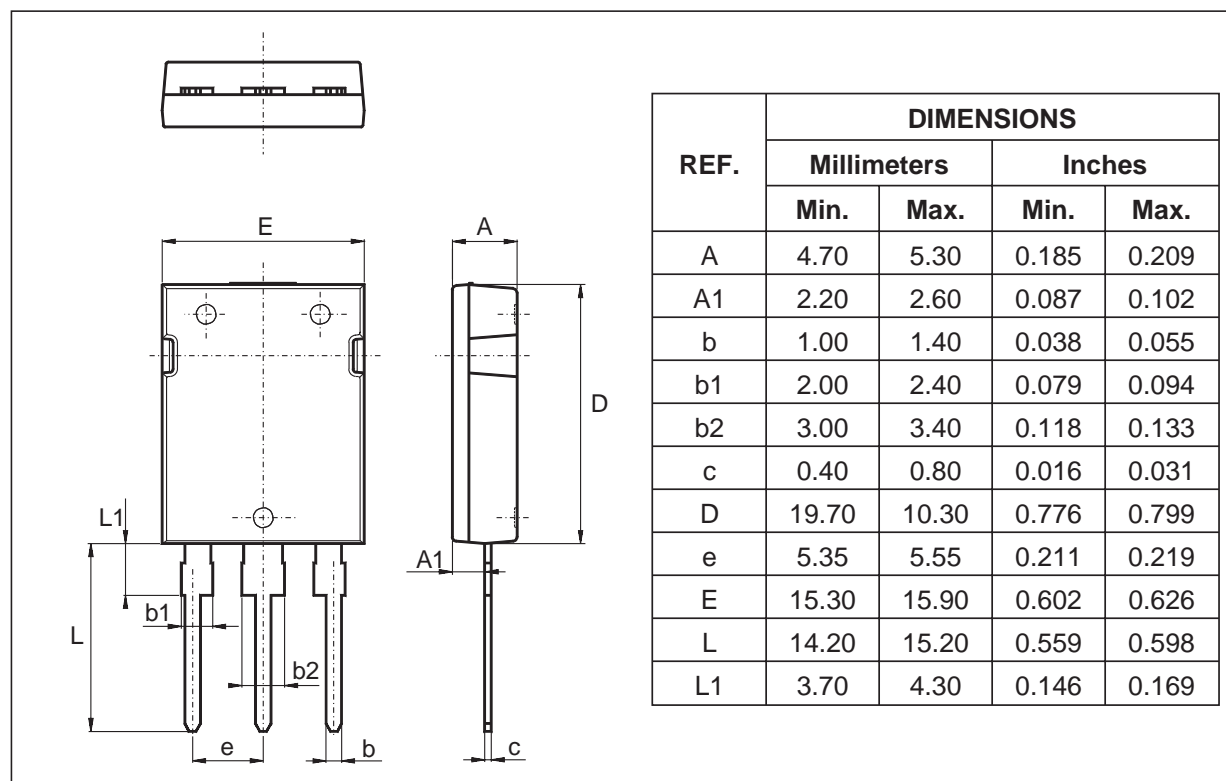

Fig. 9: Forward voltage drop versus forward current (per diode).



PACKAGE MECHANICAL DATA

Max247



Ordering type	Marking	Package	Weight	Base qty	Delivery mode
STPS80L15CY	STPS80L15CY	Max247	4.4g	30	Tube

- Cooling method: by conduction (C)
- Epoxy meets UL94,V0

Information furnished is believed to be accurate and reliable. However, STMicroelectronics assumes no responsibility for the consequences of use of such information nor for any infringement of patents or other rights of third parties which may result from its use. No license is granted by implication or otherwise under any patent or patent rights of STMicroelectronics. Specifications mentioned in this publication are subject to change without notice. This publication supersedes and replaces all information previously supplied. STMicroelectronics products are not authorized for use as critical components in life support devices or systems without express written approval of STMicroelectronics.

The ST logo is a registered trademark of STMicroelectronics

© 2003 STMicroelectronics - Printed in Italy - All rights reserved.

STMicroelectronics GROUP OF COMPANIES

Australia - Brazil - Canada - China - Finland - France - Germany
 Hong Kong - India - Israel - Italy - Japan - Malaysia - Malta - Morocco - Singapore
 Spain - Sweden - Switzerland - United Kingdom - United States.

<http://www.st.com>